

## Side View Series 0612 24V 5W

- Extrusion process, lights soft and uniform;
- IP67 protection, easy-to install and convenient connection;

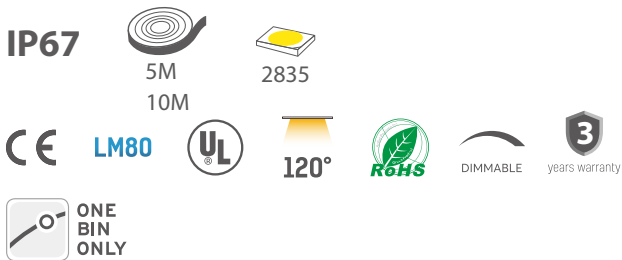

### TECHNICAL DETAILS

Power	5W/M
Voltage	DC24V
CRI	90
Led Qty	120LEDs/M
Length/Reel	5M - 10M
Working Temperature	-25~60°C
Storage Temperature	-30~80°C
Voltage Range	23 ~25V dc
Reverse Voltage	25V dc

### LIGHT DISTRIBUTION

LUMINOUS INTENSITY DISTRIBUTION DIAGRAM

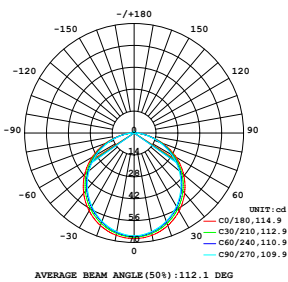

CO PLANE ISOLUX DIAGRAM (UNIT:lx)

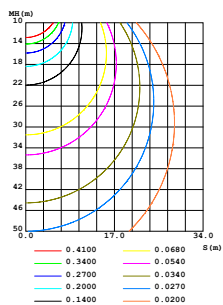

### LUMENS PER METER

#### Color Temperature

2200K	110lm
2400K	120lm
2700K	125lm
3000K	135lm
4000K	140lm
6000K	140lm

## DIMENSION

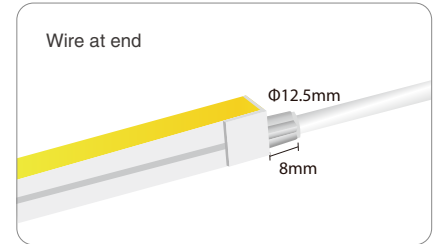
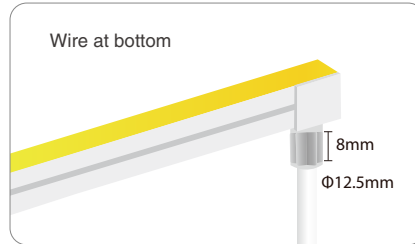
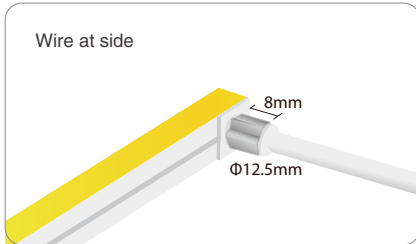
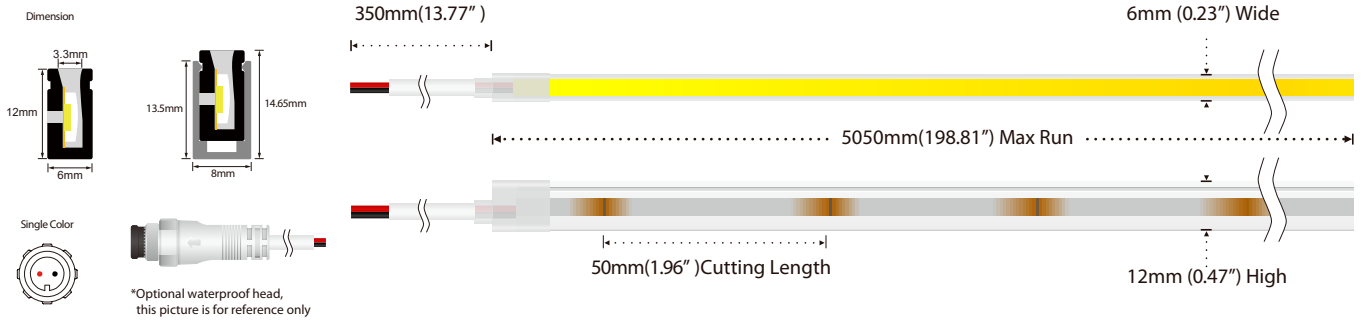

## ACCESSORIES SPECIFICATION

Name	Quantity	Note
① End cap	4pc	
② Front outlet end cap	2pc	
③ Clips	10pc	
④ Screw	10pc	
⑤ Glue	2pc	
⑥ Glue nozzle	2pc	

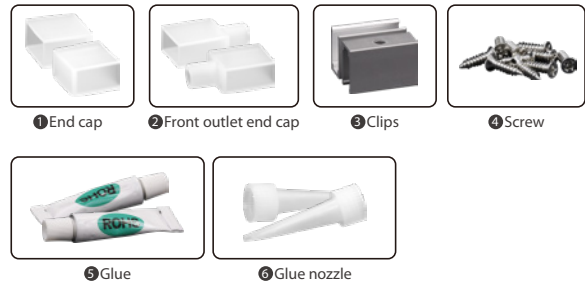

## ALUMINUM PROFILE LIST

	Product NO.	Section diagram	install
	6×12mm		
	6×12mm		

## POWER CONNECTION DIAGRAM

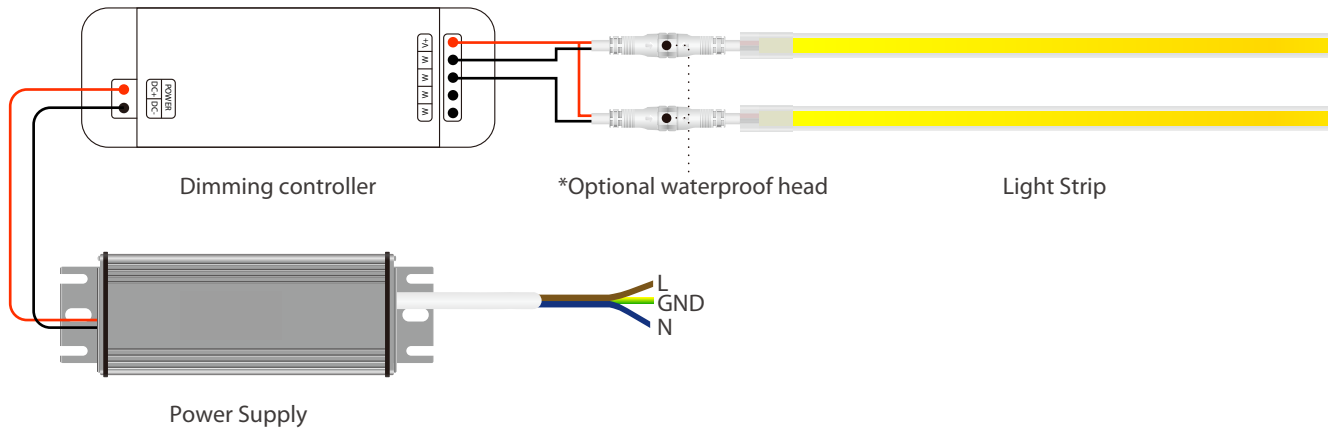

## INSTALL

### Attention

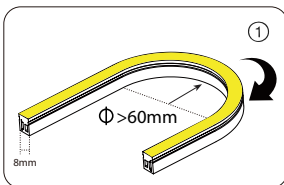

1. Correct bending way  
Luminous surface width  $< 10\text{mm}$   
Side bending Series

### Intallation

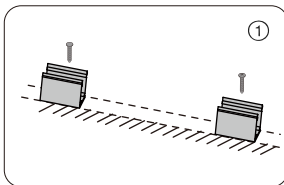

1. Installation of clip  
Fix the clips and aluminum profile via the screws  
**▲ Suggestion: 2pcs clips per meter.**

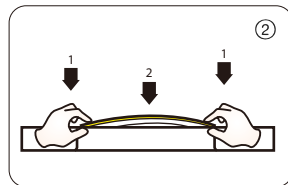

2. Installation of Neon  
Simultaneously install the neon from both ends

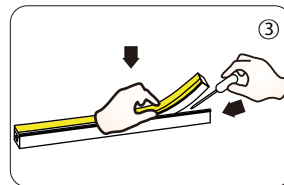

3. Installation of Neon  
Should use tools to assist when remove the neon

## Cutting/Soldering/Intall end cap

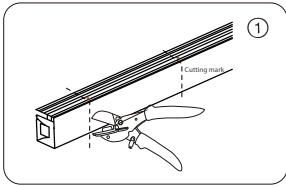

1. Cut the neon to be required length

⚠ The minimum cutting unit is based on the cutting mark.

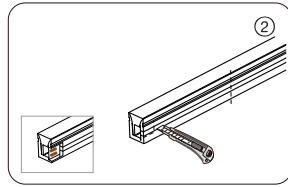

2. Cut the side of neon, expose the soldering pad

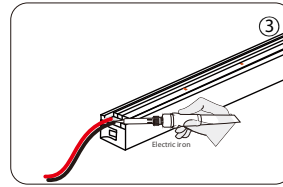

3. Solder the cable onto the PCB

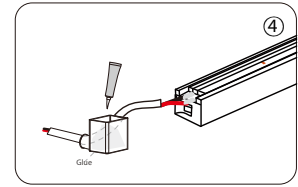

4. Put the wire into and inject glue into the end cap

⚠ The amount of glue is about 1/3-1/2 of end cap

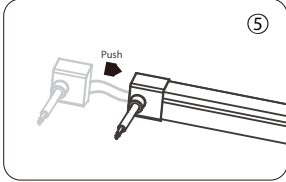

5. Push the end cap to wrap end of neon

⚠ After the glue is injected, the neon needs to be laid flat for 2 hours to before other process.

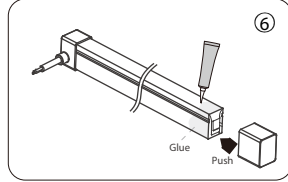

6. Apply gel around the tail of neon and install the end cap

⚠ After the glue is injected, the neon needs to be laid flat for 2 hours to before project process. Glue will complete dry after 24hours.

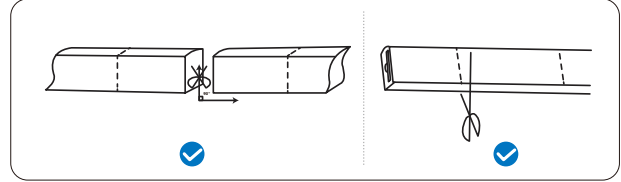

## Installation of No-Soldering Connector

1. Installation of power cord connector

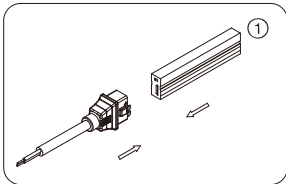

1. Push Neon into the connector

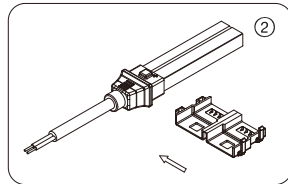

2. Wrap the connector with the faster

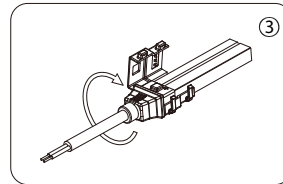

3. Press the fastener, let the bayonet slid into the corresponding slot

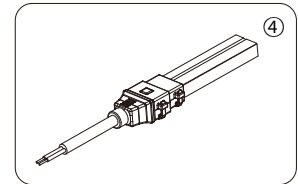

4. Check if nstallation is firm & in place

### INSTALL

## Installation of No-Soldering Connector

2. Installation of connector

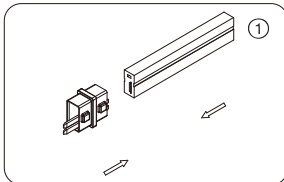

1. Push 1st part neon into the connector

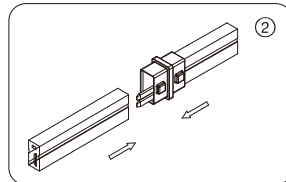

2. Push 2nd strip light part into another end

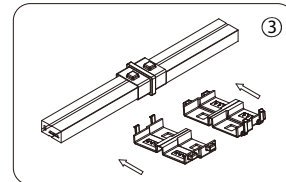

3. Wrap the both sides of connector with the fastener

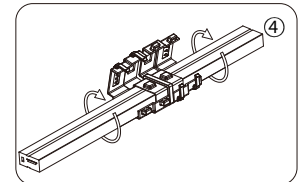

4. Press the fastener, let the bayonet slid into the corresponding slot

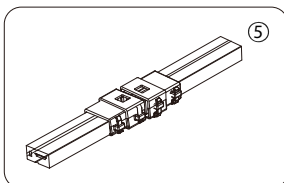

1. Check if installation is firm & in place



**Note:** We need to add glue to make the connection waterpr oof.

# Neon Solderless Terminal Installation Instructions

## 1、 Installation Instructions

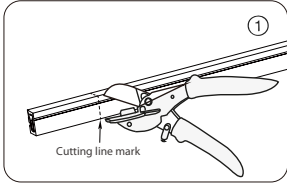

### 1. Preparation before installation: Cut neon strip

- ⚠ The cutting to be aligned the cutting line and the cutting cuts should be flat;
- ⚠ The PCB backing silk print lines need to be cut completely to avoid leaving the silk print line insulation to cause connection failure.

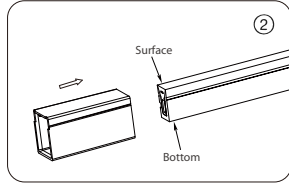

### 2. Put on transparent PC Cover

- ⚠ The screen print direction on the bottom of the PC Cover is aligned with the bottom of the neon light, as arrow direction.

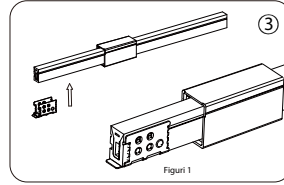

### 3. Install the stainless steel inner clips

- ⚠ Open the inner clips slightly to fit the neon strip, the end of the neon is about 1-2mm away from the edge of the inner clips. (figure 1)

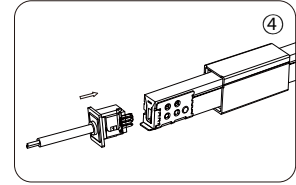

### 4. Push the end connector (with or without wire) into the neon strip

- ⚠ To check whether the waterproof silicone is flat and aligned, and the cut corner is opposite to the negative terminal of the end connector;
- ⚠ lit test after installation.

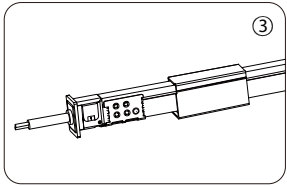

### 3. Inner clips installation

- ⚠ Align the left end connector and the right ending of the inner clips with the middle stainless steel clips, and push into the middle stainless steel clips.

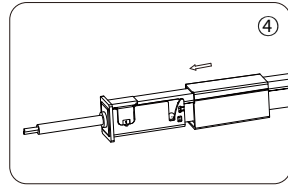

### 4. Install the transparent PC outer clips: tighten the outer clips as shown in the figure

## PACKING

Box dimension(mm)	Carton dimension(mm)	Electrostatic size(mm)	Reel size(mm)	outer box(bags/carton)
500×260×380	360×240×240	280×260	8×16	30
Net weight (kg)	Each box net(kg)	Gross weight of each box(kg)	Bag quantity(bags/carton)	
0.58	17.4	18.7	15	

